

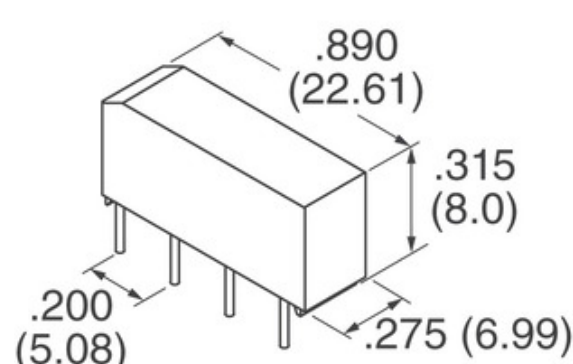

Coto Technology

## 9081-12-10

Nomor bagian:	9081-12-10
Pabrikan / Merek:	Coto Technology
Deskripsi Produk	RELAY REED SPST 500MA 12V
Lembar data:	<a href="#">PDF 9081-12-10.pdf</a>
Status RoHS	 Memimpin bebas / RoHS Compliant
Kirim Dari	Hongkong
Cara pengiriman	DHL/Fedex/TNT/UPS/EMS



Gambar bisa berupa representasi. Lihat spesifikasi untuk detail produk.

[PERMINTAAN KUTIPAN](#)











## Spesifikasi 9081-12-10

NOMOR BAGIAN	9081-12-10
PABRIKAN	Coto Technology
DESKRIPSI	RELAY REED SPST 500MA 12V
MEMIMPIN STATUS BEBAS / STATUS ROHS	Memimpin bebas / RoHS Compliant
LEMBARAN DATA	<a href="#">PDF 9081-12-10.pdf</a>
TURN ON VOLTAGE (MAX)	9 VDC
TURN OFF VOLTAGE (MIN)	1 VDC
PENGHENTIAN STYLE	PC Pin
SWITCHING TEGANGAN	200VAC, 200VDC - Max
SERI	9000, Spartan
RILIS WAKTU	0.2ms
PENGEMASAN	Tube
NAMA LAIN	306-1139
SUHU OPERASIONAL	-20°C ~ 85°C
MENGOPERASIKAN WAKTU	0.5ms
MOUNT JENIS	Through Hole
MOISTURE SENSITIVITY LEVEL (MSL)	1 (Unlimited)
STATUS GRATIS MEMIMPIN / STATUS ROHS	Lead free / RoHS Compliant
FITUR	EMI Shielded
HUBUNGI PENILAIAN (SEKARANG)	500mA
KONTAK MATERIAL	-
FORMULIR KONTAK	SPST-NO (1 Form A)
COIL VOLTAGE	12VDC
COIL TYPE	Non Latching
RESISTANCE COIL	1 kOhms
COIL DAYA	-
COIL SEKARANG	12.0mA

## Tag terkait

<a href="#">Coto Technology 9081-12-10</a>	<a href="#">Distributor 9081-12-10</a>	<a href="#">Pemasok 9081-12-10</a>
<a href="#">Harga 9081-12-10</a>	<a href="#">Gambar 9081-12-10</a>	<a href="#">Gambar 9081-12-10</a>
<a href="#">Lembar Data PDF 9081-12-10</a>	<a href="#">9081-12-10 Unduh Lembar Data</a>	<a href="#">Lembar Data 9081-12-10</a>
<a href="#">Stok 9081-12-10</a>	<a href="#">Beli 9081-12-10</a>	<a href="#">Beli Coto Technology 9081-12-10</a>
<a href="#">Coto Technology 9081-12-10</a>	<a href="#">Pemasok Coto Technology</a>	<a href="#">Distributor Coto Technology</a>
<a href="#">Coto Technology 9081-12-10</a>		

### Produk-produk terkait

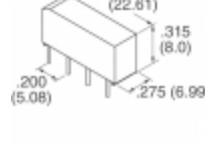
 <p><b>9081110700</b>          Produsen: Essentra Components          Deskripsi: SWING HANDLE LATCH METAL SEALED          Persediaan: 25 pcs  <a href="#">RFQ</a></p>	 <p><b>9081-05-40</b>          Produsen: Coto Technology          Deskripsi: RELAY REED SPST 500MA 5V          Persediaan: Out stock  <a href="#">RFQ</a></p>
 <p><b>9081-12-00</b>          Produsen: Coto Technology          Deskripsi: RELAY REED SPST 500MA 12V          Persediaan: Out stock  <a href="#">RFQ</a></p>	 <p><b>9081-12-50</b>          Produsen: Coto Technology          Deskripsi: RELAY REED SPST 500MA 12V          Persediaan: Out stock  <a href="#">RFQ</a></p>
 <p><b>9081-05-00</b>          Produsen: Coto Technology          Deskripsi: RELAY REED SPST 500MA 5V          Persediaan: Out stock  <a href="#">RFQ</a></p>	 <p><b>9081-0-00-34-00-00-08-0</b>          Produsen: Mill-Max          Deskripsi: CONN PC PIN CIRC .020DIA GOLD          Persediaan: Out stock  <a href="#">RFQ</a></p>
 <p><b>9081-12-40</b>          Produsen: Coto Technology          Deskripsi: RELAY REED SPST 500MA 12V          Persediaan: Out stock  <a href="#">RFQ</a></p>	 <p><b>9081110000</b>          Produsen: Essentra Components          Deskripsi: SWING HANDLE LATCH METAL SEALED          Persediaan: 25 pcs  <a href="#">RFQ</a></p>
 <p><b>9081-0-00-80-00-00-08-0</b>          Produsen: Mill-Max          Deskripsi: CONN PC PIN          Persediaan: Out stock  <a href="#">RFQ</a></p>	 <p><b>9081-05-10</b>          Produsen: Coto Technology          Deskripsi: RELAY REED SPST 500MA 5V          Persediaan: Out stock  <a href="#">RFQ</a></p>
 <p><b>9081-24-00</b>          Produsen: Coto Technology          Deskripsi: RELAY REED SPST 500MA 24V          Persediaan: Out stock  <a href="#">RFQ</a></p>	 <p><b>9081-24-10</b>          Produsen: Coto Technology          Deskripsi: RELAY REED SPST 500MA 24V          Persediaan: Out stock  <a href="#">RFQ</a></p>