

**OSRAM**  
 Opto Semiconductors

OSRAM Opto Semiconductors,

## SFH 325 FA-Z

Nomor bagian:

SFH 325 FA-Z

Pabrikan / Merek:

OSRAM Opto Semiconductors, Inc.

Deskripsi Produk

PHOTOTRANSISTOR NPN 980NM 2PLCC

Lembar data:

 SFH 325 FA-Z.pdf

Status RoHS

 Memimpin bebas / RoHS Compliant

Kirim Dari

Hongkong

Cara pengiriman

DHL/Fedex/TNT/UPS/EMS

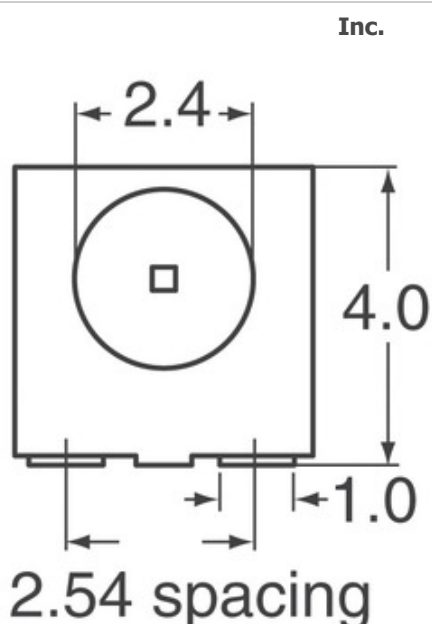

Gambar bisa berupa representasi. Lihat spesifikasi untuk detail produk.

[PERMINTAAN KUTIPAN](#)









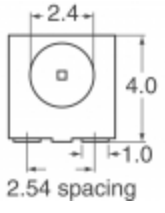

### Spesifikasi SFH 325 FA-Z

NOMOR BAGIAN	SFH 325 FA-Z
PABRIKAN	OSRAM Opto Semiconductors, Inc.
DESKRIPSI	PHOTOTRANSISTOR NPN 980NM 2PLCC
MEMIMPIN STATUS BEBAS / STATUS ROHS	Memimpin bebas / RoHS Compliant
LEMBARAN DATA	 SFH 325 FA-Z.pdf
PANJANG GELOMBANG	980nm
TEGANGAN - KOLEKTOR EMITTER BREAKDOWN (MAX)	35V
MELIHAT SUDUT	120°
SERI	SIDELED
LISTRİK - MAX	165mW
PENGEMASAN	Cut Tape (CT)
PAKET / CASE	2-LCC (J-Lead)
NAMA LAIN	475-3569-1
ORIENTASI	Side View
SUHU OPERASIONAL	-40°C ~ 100°C (TA)
MOUNT JENIS	Surface Mount, Right Angle
MOISTURE SENSITIVITY LEVEL (MSL)	2 (1 Year)
MANUFACTURER STANDARD LEAD TIME	14 Weeks
STATUS GRATIS MEMIMPIN / STATUS ROHS	Lead free / RoHS Compliant
DETIL DESKRIPSI	Phototransistor 980nm Side View 2-LCC (J-Lead)
SAAT INI - DARK (ID) (MAX)	50nA
SAAT INI - KOLEKTOR (IC) (MAX)	15mA

### Tag terkait

OSRAM Opto Semiconductors, Inc. SFH 325 FA-Z	Distributor SFH 325 FA-Z	Pemasok SFH 325 FA-Z
Harga SFH 325 FA-Z	Gambar SFH 325 FA-Z	Gambar SFH 325 FA-Z
Lembar Data PDF SFH 325 FA-Z	SFH 325 FA-Z Unduh Lembar Data	Lembar Data SFH 325 FA-Z
Stok SFH 325 FA-Z	Beli SFH 325 FA-Z	Beli OSRAM Opto Semiconductors, Inc. SFH 325 FA-Z
OSRAM Opto Semiconductors, Inc. SFH 325 FA-Z	Pemasok OSRAM Opto Semiconductors, Inc.	Distributor OSRAM Opto Semiconductors, Inc.
OSRAM Opto Semiconductors, Inc. SFH 325 FA-Z	OSRAM Opto Semiconductors Inc. SFH 325 FA-Z	

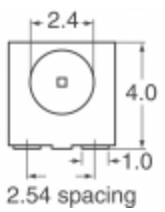
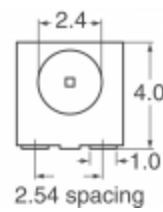
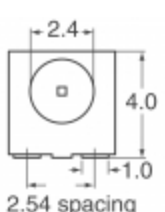
### Produk-produk terkait

 <p><b>SFH 325-3-Z</b>          Produsen: OSRAM Opto Semiconductors, Inc.          Deskripsi: PHOTOTRANSISTOR NPN 980NM 2PLCC          Persediaan: Out stock</p> <p><a href="#">RFQ</a></p>	 <p><b>SFH 325-3/4-Z</b>          Produsen: OSRAM Opto Semiconductors, Inc.          Deskripsi: PHOTOTRANS NPN SIDELED 2SMD          Persediaan: Out stock</p> <p><a href="#">RFQ</a></p>
 <p><b>SFH 325 FA-3/4-Z</b>          Produsen: OSRAM Opto Semiconductors, Inc.          Deskripsi: PHOTOTRANS NPN SIDELED 2SMD          Persediaan: Out stock</p> <p><a href="#">RFQ</a></p>	 <p><b>SFH 331-JK</b>          Produsen: OSRAM Opto Semiconductors, Inc.          Deskripsi: PHOTOTRANSISTOR/EMITTER SMD          Persediaan: Out stock</p> <p><a href="#">RFQ</a></p>
 <p><b>SFH 325-Z</b>          Produsen: OSRAM Opto Semiconductors, Inc.          Deskripsi: PHOTOTRANSISTOR SIDELED          Persediaan: Out stock</p> <p><a href="#">RFQ</a></p>	 <p><b>SFH 3211 FA-3/4-Z</b>          Produsen: OSRAM Opto Semiconductors, Inc.          Deskripsi: PHOTOTRANSISTOR NPN 890NM REV GW          Persediaan: Out stock</p> <p><a href="#">RFQ</a></p>
 <p><b>SFH 3211 FA-Z</b>          Produsen: OSRAM Opto Semiconductors, Inc.          Deskripsi: PHOTOTRANSISTOR NPN 890NM REV GW          Persediaan: Out stock</p> <p><a href="#">RFQ</a></p>	 <p><b>SFH 3310</b>          Produsen: OSRAM Opto Semiconductors, Inc.          Deskripsi: PHOTOTRANS NPN 570NM 3MM CLEAR          Persediaan: Out stock</p> <p><a href="#">RFQ</a></p>
 <p><b>SFH 325 FA-3-Z</b>          Produsen: OSRAM Opto Semiconductors, Inc.          Deskripsi: PHOTOTRANSISTOR NPN 980NM 2PLCC          Persediaan: Out stock</p> <p><a href="#">RFQ</a></p>	 <p><b>SFH 325 FA-4-Z</b>          Produsen: OSRAM Opto Semiconductors, Inc.          Deskripsi: PHOTOTRANSISTOR NPN 980NM 2PLCC          Persediaan: Out stock</p> <p><a href="#">RFQ</a></p>
 <p><b>SFH 325-4-Z</b>          Produsen: OSRAM Opto Semiconductors, Inc.          Deskripsi: PHOTOTRANSISTOR NPN 980NM 2PLCC          Persediaan: Out stock</p> <p><a href="#">RFQ</a></p>	 <p><b>SFH 3219-Z</b>          Produsen: OSRAM Opto Semiconductors, Inc.          Deskripsi: PHOTOTRANS NPN TOPLED W/LENS SMD          Persediaan: Out stock</p> <p><a href="#">RFQ</a></p>

Hak Cipta © 2020 Distributor Komponen Elektronik yang Andal - Ocean-Components.com

E-mail: Info@Ocean-Components.com

Alamat: Room 2102, Connaught Commercial Building, 185 Wan Chai Rd, Wan Chai, Hong Kong

